

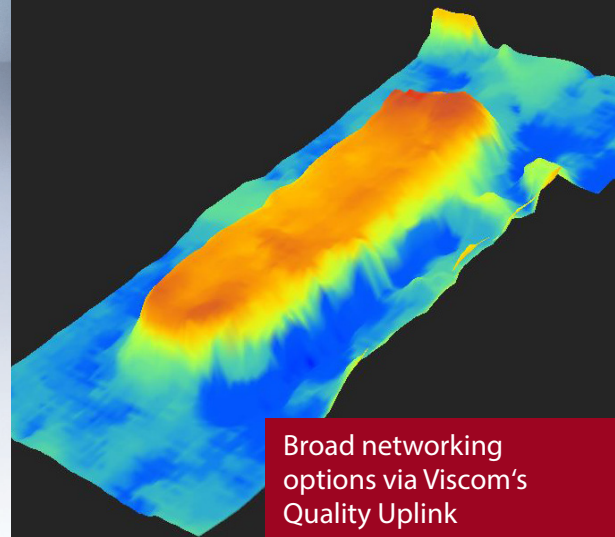

## High-End SPI System for In-Line Manufacturing



Broad networking  
options via Viscom's  
Quality Uplink

### **iS6059 SPI**

Excellent technology for solder  
and sinter paste inspection

3D SPI

# High-Throughput Paste Inspection with Maximum Accuracy

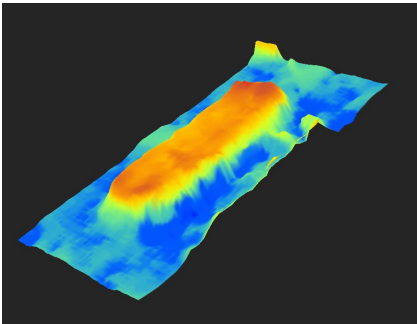

Color-assisted 3D solder paste volume calculation

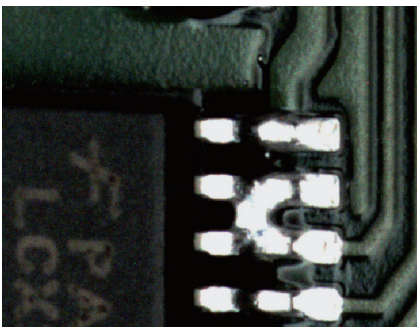

Paste bridge after soldering

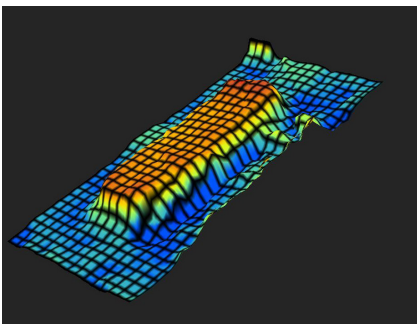

3D solder paste volume calculation with grid pattern

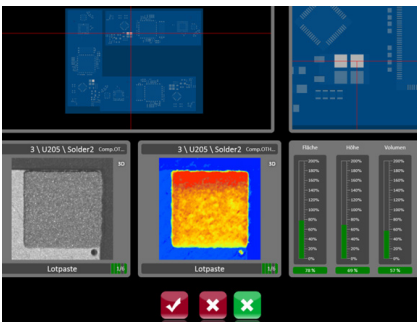

User-friendly overviews in vVision

---

**Extremely high throughput due to FastFlow handling**

---

**Enhanced quality and speed of inspection**

---

**Four angled views for shadow-free inspection images**

---

**High reproducibility**

---

**Very easy operation: color images for verification and efficient program generation**

---

**Customer hotline and website, remote maintenance**

---

The iS6059 SPI is a 3D SPI system that offers unbeatable advantages for economical SMT production. Key features include an inspection speed of 90 cm<sup>2</sup>/s and a field of view size of 58 mm by 58 mm. The orthogonal optical resolution is 12 μm and is combined with four angled views to deliver perfect, shadow-free inspection results – which are key for very small inspection areas. Viscom's optional FastFlow handling offers extremely high throughput rates. Assemblies are synchronously infed and outfed at high speed.

This system, configured to meet optimum cost/benefit aspects, is based on the unique and proven XM camera technology from Viscom and combines precise defect detection with the highest inspection speed. The iS6059 SPI inspects all quality criteria for solder paste deposits, including volume, shape, surface, height, offset, paste bridges and paste smearing.

Evaluating the 3D measurement data and linking the results via Quality Uplink with the paste printer, placement system, AOI and AXI allows for effective process control and sustainable quality improvement. In this way, Viscom's 3D SPI system delivers indications of process weaknesses that can be automatically adapted, e.g. adjusting the screen cleaning cycles or correcting print displacement or placement offset.



# Technical Specifications

## iS6059 SPI

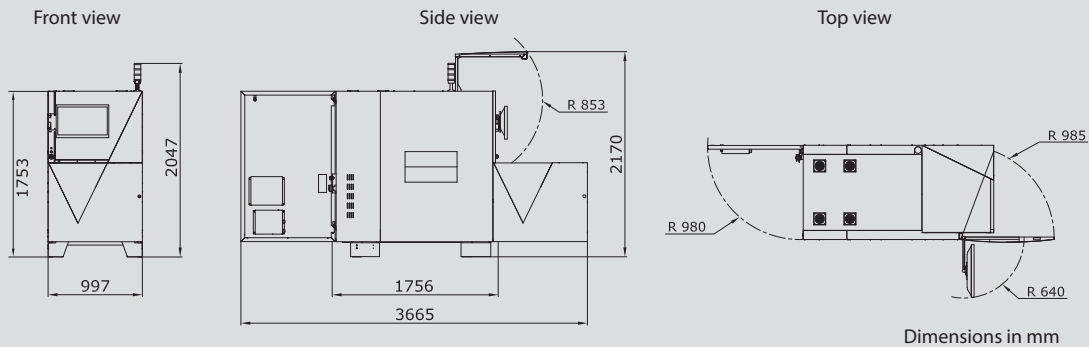

iS6059 SPI		
<b>Inspection scope</b>		Solder paste deposits (stencil printing or dispensing technology, up to pad sizes for 01005 components); sinter paste, adhesives, surface, height, print displacement, smearing, shape, coplanarity, open area analysis, OCR, DMC
<b>Camera technology</b>		XM-SPI-II
	3D sensor technology	
	Z-resolution	0.1 $\mu$ m
	Z-range	Up to 5 mm (0.2")
	Angled view cameras	
	Number of megapixel cameras	4
	Orthogonal camera	
	Resolution	12 $\mu$ m
	Field of view	58 mm x 58 mm (2.3" x 2.3")
<b>Inspection speed</b>		Up to 90 cm <sup>2</sup> /s
<b>Software</b>	User interface	Viscom vVision/SI EasyPro
	Statistical process control	Viscom vSPC/SPC, open interface (optional)
	Verification station	Viscom vVerify/HARAN
	Remote diagnosis	Viscom SRC (optional)
	Programming station	Viscom PST34 (optional)
<b>System computer</b>	Operating system	Windows®
	Processor	Intel®Core™i7
<b>PCB handling</b>	PCB dimensions	508 mm x 508 mm (20" x 20"); long-board option available
	PCB support	Optional
	Transport height	850 - 950 mm $\pm$ 20 mm (33.5" - 37.4" $\pm$ 0.8")
	Width adjustment	Automatic
	Transport concept	Single-track transport system; dual-lane option available
	PCB clamping	Pneumatic
	Upper transport clearance	50 mm (2")
	Lower transport clearance	50 mm (2")
<b>Other system data</b>	Positioning unit	Synchronous linear motor
	Interfaces	SMEMA, Hermes, CFX, third-party providers
	Power requirements	400 V, 50 Hz, 3P/N/PE +/- 10%; 4 - 6 bar working pressure
	System dimensions	997 mm x 1756 mm x 1753 mm (39.3" x 69.1" x 69") (W x D x H)
	Weight	Approx. 1060 kg (2337 lbs)

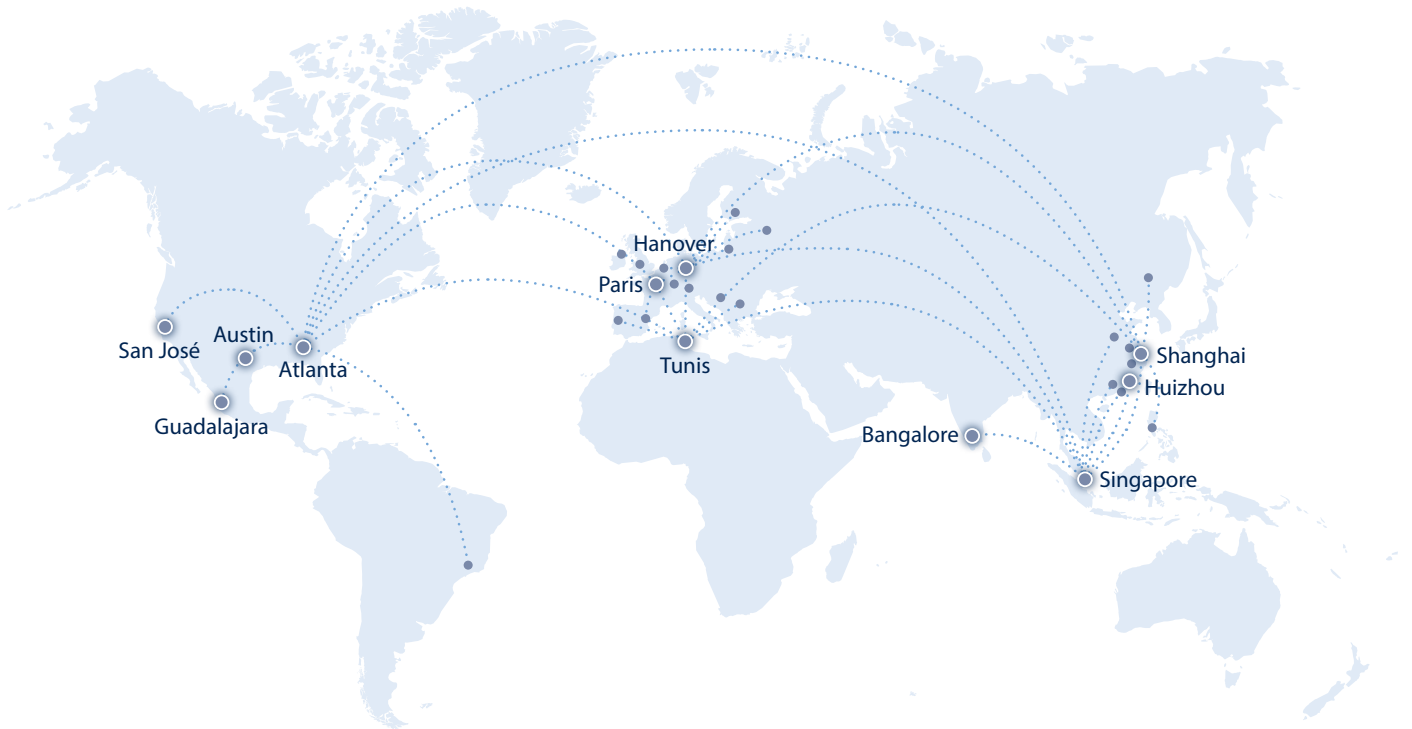

**Headquarters:**

**Viscom SE**

Carl-Buderus-Str. 9–15  
30455 Hanover  
Germany  
Phone: +49 511 94996-0  
Email: info@viscom.de

**Europe**

**Viscom France S.A.R.L.**

6, rue Saint Simon  
Zone du Vert Galant  
95310 Saint-Ouen l'Aumône  
France  
Phone: +33 134 641616  
Email: info@viscom.fr

**Africa**

**Viscom Tunisie S.A.R.L.**

Rahma Building; App B5,  
Block B, 2nd floor  
Lac Houran Street – Berges  
du Lac  
1053 Tunis, Tunisia  
Phone: +216 71960584  
Email: info@viscom.fr

**Americas**

**Viscom Inc.**

1775 Breckinridge Parkway  
Suite 500, Duluth (Atlanta)  
GA 30096, USA  
Phone: +1 678 966-9835  
Email: info@viscomusa.com

**Viscom Inc.**

898 B Faulstich Court  
San José, CA 95112, USA  
Phone: +1 818 4160514  
Email: info@viscomusa.com

**Viscom Inc.**

9600 Great Hills Trail Suite  
150 W, Unit# 144  
Austin, TX 78759, USA  
Phone: +1 737 280-5759  
Email: info@viscomusa.com

**Viscom Inc.**

Av. Vallarta 6503  
Concentro Local F-27  
Zapopan (Guadalajara)  
JAL. C.P. 45010, Mexico  
Phone: +52 333110-1567  
Email: info@viscomusa.com

**Asia**

**Viscom Machine Vision Pte. Ltd.**

150 Kampong Ampat/  
#01-02 KA Centre  
368324 Singapore  
Singapore  
Phone: +65 62859-891  
Email: info@viscom.com.sg

**Viscom Machine Vision Trading Co. Ltd.**

2nd floor, Block D  
No. 1010 Kaixuan Road  
200052 Shanghai, China  
Phone: +86 21 61619368  
Email: info@viscom.cn

**VICN Automated Inspection Technology (Huizhou) Co. Ltd.**

2nd Hechang Road No. 25  
Zhongkai High-tech Zone  
516006 Huizhou City  
Guangdong province, China  
Phone: +86 752 2607785  
Email: info@viscom.cn

**Viscom Machine Vision (India) Pvt. Ltd.**

No. 2, Katha, No. 279/283  
Hulimangala Village  
Jigani Hobli, Anekal Taluk  
Bangalore 560105, India  
Phone: +91 9481202030  
Email: info@viscom.com.sg

[www.viscom.com](http://www.viscom.com)



Viscom also works with an extensive network of local representatives and distributors in Europe, the Americas, Asia and Africa. Please refer to our website for a list of our representatives and distributors.